



Satellite[®] A100/A105 Series Resource Guide

NOTE Keep this guide in a convenient place to access important information about your computer.

If you need assistance, use one of the following:

- ❖ Toshiba's Support Web site
pcsupport.toshiba.com
- ❖ Toshiba Global Support Centre
Calling within the United States (800) 457-7777
Calling from outside the United States (949) 859-4273

Please fill in for your reference and future use:

Model name _____

Part number _____

Serial number _____

Contents

Introduction	25
Setting up your computer and getting started.....	26
Your computer's TFT display	36
Inserting a PC Card	36
Learning the basics.....	37
Using the TouchPad™/Dual Mode Pad.....	38
Using the Optical drive.....	39
Moving the computer.....	44
Mobile computing.....	44
Taking care of your battery	48
If something goes wrong.....	51
If you need further assistance.....	56
Power cord/cable connectors	58
Features and specifications.....	58
Legal Footnotes	65
Index	68

▲ WARNING

Handling the cord on this product will expose you to lead, a chemical known to the State of California to cause birth defects or other reproductive harm.
Wash hands after handling.

Model: Satellite® A100/A105 Series

Recordable and/or ReWritable Drive(s) and Associated Software Warranty

The computer system you purchased may include Recordable and/or ReWritable optical media drive(s) and associated software, among the most advanced data storage technologies available. As with any new technology, you must read and follow all set-up and usage instructions in the applicable user guides and/or manuals enclosed or provided electronically. If you fail to do so, this product may not function properly and you may lose data or suffer other damage. TOSHIBA AMERICA INFORMATION SYSTEMS, INC. ("TOSHIBA"), ITS AFFILIATES AND SUPPLIERS DO NOT WARRANT THAT OPERATION OF THE PRODUCT WILL BE UNINTERRUPTED OR ERROR FREE. YOU AGREE THAT TOSHIBA, ITS AFFILIATES AND SUPPLIERS SHALL HAVE NO RESPONSIBILITY FOR DAMAGE TO OR LOSS OF ANY BUSINESS, PROFITS, PROGRAMS, DATA, NETWORK SYSTEMS OR REMOVABLE STORAGE MEDIA ARISING OUT OF OR RESULTING FROM THE USE OF THE PRODUCT, EVEN IF ADVISED OF THE POSSIBILITY THEREOF.

Protection of Stored Data

For your important data, please make periodic back-up copies of all the data stored on the hard disk or other storage devices as a precaution against possible failures, alteration, or loss of the data. **IF YOUR DATA IS ALTERED OR LOST DUE TO ANY TROUBLE, FAILURE OR MALFUNCTION OF THE HARD DISK DRIVE OR OTHER STORAGE DEVICES AND THE DATA CANNOT BE RECOVERED, TOSHIBA SHALL NOT BE LIABLE FOR ANY DAMAGE OR LOSS OF DATA, OR ANY OTHER DAMAGE RESULTING THEREFROM. WHEN COPYING OR TRANSFERRING YOUR DATA, PLEASE BE SURE TO CONFIRM WHETHER THE DATA HAS BEEN SUCCESSFULLY COPIED OR TRANSFERRED. TOSHIBA DISCLAIMS ANY LIABILITY FOR THE FAILURE TO COPY OR TRANSFER THE DATA CORRECTLY.**

Critical Applications

The computer you have purchased is not designed for any “critical applications.” “Critical applications” means life support systems, medical applications, connections to implanted medical devices, commercial transportation, nuclear facilities or systems or any other applications where product failure could lead to injury to persons or loss of life or catastrophic property damage. **ACCORDINGLY, TOSHIBA, ITS AFFILIATES AND SUPPLIERS DISCLAIM ANY AND ALL LIABILITY ARISING OUT OF THE USE OF THE COMPUTER PRODUCTS IN ANY CRITICAL APPLICATIONS. IF YOU USE THE COMPUTER PRODUCTS IN A CRITICAL APPLICATION, YOU, AND NOT TOSHIBA, ASSUME FULL RESPONSIBILITY FOR SUCH USE.**

FCC Notice “Declaration of Conformity Information”

This equipment has been tested and found to comply with the limits for a Class B digital device, pursuant to Part 15 of the FCC rules. These limits are designed to provide reasonable protection against harmful interference in a residential installation.

This equipment generates, uses and can radiate radio frequency energy and, if not installed and used in accordance with the instructions, it may cause harmful interference to radio communications. However, there is no guarantee that interference will not occur in a particular installation. If this equipment does cause harmful interference to radio or television reception, which can be determined by turning the equipment off and on, the user is encouraged to try to correct the interference by one or more of the following measures:

- ❖ Reorient or relocate the receiving antenna.
- ❖ Increase the separation between the equipment and receiver.
- ❖ Connect the equipment to an outlet on a circuit different from that to which the receiver is connected.
- ❖ Consult the dealer or an experienced radio/TV technician for help.

NOTE

Only Peripherals complying with the FCC Class B limits may be attached to this equipment. Operation with noncompliant peripherals or peripherals not recommended by Toshiba is likely to result in interference to radio and TV reception. Shielded cables must be used between the external devices and the computer's parallel port, monitor port, USB port, PS/2 port®, i.LINK® port and microphone jack. Changes or modifications made to this equipment not expressly approved by Toshiba or parties authorized by Toshiba could void the user's authority to operate the equipment.

This device complies with Part 15 of the FCC Rules. Operation is subject to the following two conditions:

- ❖ This device may not cause harmful interference.
- ❖ This device must accept any interference received, including interference that may cause undesired operation.

Contact either:

- ❖ Toshiba's Support Web site at pcsupport.toshiba.com.
- ❖ Or call the Toshiba Global Support Centre:
Within the United States at (800) 457-7777
Outside the United States at (949) 859-4273

Industry Canada Requirement

This Class B digital apparatus complies with Canadian ICES-003.

Cet appareil numérique de la classe B est conforme à la norme NMB-003 du Canada.

FCC requirements

The following information is pursuant to FCC CFR 47, Part 68 and refers to internal modems.

This equipment complies with Part 68 of the FCC rules. On the bottom of this equipment is a label that contains, among other information, the FCC registration number and ringer equivalence number (REN) for this equipment. If requested, the information must be provided to the telephone company.

The modem connects to the telephone line by means of a standard jack called the USOC RJ11C.

A plug and jack used to connect this equipment to the premises wiring and telephone network must comply with the applicable FCC part 68 rules and requirements adopted by the ACTA. It is designed to be connected to a compatible modular jack that is also compliant.

The REN is used to determine the number of devices that may be connected to a telephone line. Excessive RENs on a telephone line may result in the devices not ringing in response to an incoming call. In most but not all areas, the sum of RENs should not exceed five (5.0). To be certain of the number of devices that may be connected to a line, as determined by the total RENs, contact the local telephone company. For products approved after July 23, 2001, the REN for this product is part of the product identifier that has the format US:AAAEQ##TXXXX. The digits represented by the ## are the REN without a decimal point (e.g., 03 is a REN of 0.3). For earlier products, the REN is separately shown on the label.

Connection to party line service is subject to state tariffs. Contact the state public utility commission, public service commission or corporation commission for information.

Telephone Company Procedures

The goal of the telephone company is to provide you with the best service it can. In order to do this, it may occasionally be necessary for them to make changes in their equipment, operations or procedures. If these changes might affect your service or the operation of your equipment, the telephone company will give you notice, in writing, to allow you to make any changes necessary to maintain uninterrupted service.

If Problems Arise

If this equipment causes harm to the telephone network, the telephone company will notify you in advance that temporary discontinuance of service may be required. But if advanced notice is not practical, the telephone company will notify the customer as soon as possible. Also, you will be advised of your right to file a complaint with the FCC if you believe it is necessary.

If trouble is experienced with this equipment, for repair or limited warranty information, please contact Toshiba Corporation, Toshiba America Information Systems, Inc. or an authorized representative of Toshiba, or the Toshiba Support Centre within the United States at (800) 457-7777 or Outside the United States at (949) 859-4273. If the equipment is causing harm to the telephone network, the telephone company may request that you disconnect the equipment until the problem is resolved.

Disconnection

If you should ever decide to permanently disconnect your modem from its present line, please call the telephone company and let them know of this change.

Fax Branding

The Telephone Consumer Protection Act of 1991 makes it unlawful for any person to use a computer or other electronic device, including Fax machines, to send any message unless such message clearly contains in a margin at the top or bottom of each transmitted page or on the first page of the transmission, the date and time it is sent and an identification of the business or other entity, or other individual sending the message and the telephone number of the sending machine or such business, other entity, or individual. (The telephone number provided may not be a 900 number or

any other number for which charges exceed local or long-distance transmission charges.)

In order to program this information into your fax transmission, refer to the fax software instructions installed on this computer.

Alarm Equipment

If your home has specially wired alarm equipment connected to the telephone line, ensure the installation of this equipment does not disable your alarm equipment. If you have questions about what will disable alarm equipment, consult your telephone company or a qualified installer.

Instructions for IC CS-03 Certified Equipment

- 1 **NOTICE:** The Industry Canada label identifies certified equipment. This certification means that the equipment meets certain telecommunications network protective, operational and safety requirements as prescribed in the appropriate Terminal Equipment Technical Requirements document(s). The Department does not guarantee the equipment will operate to the user's satisfaction. Before installing this equipment, users should ensure that it is permissible to be connected to the facilities of the local telecommunications company. The equipment must also be installed using an acceptable method of connection. The customer should be aware that compliance with the above conditions may not prevent degradation of service in some situations.

Repairs to certified equipment should be coordinated by a representative designated by the supplier. Any repairs or alterations made by the user to this equipment, or equipment malfunctions, may give the telecommunications company cause to request the user to disconnect the equipment.

Users should ensure for their own protection that the electrical ground connections of the power utility, telephone lines and internal metallic water pipe system, if present, are connected together. This precaution may be particularly important in rural areas.

Caution: Users should not attempt to make such connections themselves, but should contact the appropriate electric inspection authority, or electrician, as appropriate.

- 2 The user manual of analog equipment must contain the equipment's Ringer Equivalence Number (REN) and an explanation notice similar to the following:

The Ringer Equivalence Number (REN) of this device can be found on the label affixed to your computer.

NOTICE: The Ringer Equivalence Number (REN) assigned to each terminal device provides an indication of the maximum number of terminals allowed to be connected to a telephone interface. The

termination on an interface may consist of any combination of devices subject only to the requirement that the sum of the Ringer Equivalence Numbers of all the devices does not exceed 5.

- 3 The standard connecting arrangement (telephone jack type) for this equipment is jack type(s): USOC RJ11C.

Wireless Interoperability

The TOSHIBA Wireless LAN Mini PCI Card products are designed to be interoperable with any wireless LAN product that is based on Direct Sequence Spread Spectrum (DSSS) radio technology, and is compliant to:

- ❖ The IEEE 802.11 Standard on Wireless LANs (Revision A/B/G), as defined and approved by the Institute of Electrical and Electronics Engineers.
- ❖ The Wireless Fidelity (Wi-Fi) certification as defined by the Wi-Fi Alliance. The “Wi-Fi CERTIFIED” logo is a certification mark of the Wi-Fi Alliance.

CAUTION

Bluetooth[®] and Wireless LAN devices operate within the same radio frequency range and may interfere with one another. If you use *Bluetooth* and Wireless LAN devices simultaneously, you may occasionally experience a less than optimal network performance or even lose your network connection.

If you should experience any such problem, immediately turn off your *Bluetooth* or Wireless LAN device.

Please contact Toshiba PC product support on Web site <http://www.toshiba-europe.com/computers/tnt/bluetooth.htm> in Europe or pcsupport.toshiba.com in the United States for more information.

CAUTION

Radio Frequency Interference Requirements

This device is restricted to indoor use due to its operation in the 5.15 GHz to 5.25 GHz frequency range. FCC requires this product to be used indoors for frequency range 5.15 GHz to 5.25 GHz to reduce the potential for harmful interference to co-channel Mobile Satellite systems.

High power radars are allocated as primary users of the 5.25 GHz to 5.35 GHz and 5.65 GHz to 5.85 GHz bands. These radar stations can cause interference with and/or damage this device.

Wireless LAN and Your Health

Wireless LAN products, like other radio devices, emit radio frequency electromagnetic energy. The level of energy emitted by Wireless LAN devices however is far much less than the electromagnetic energy emitted by wireless devices like for example mobile phones.

Because Wireless LAN products operate within the guidelines found in radio frequency safety standards and recommendations, TOSHIBA believes Wireless LAN is safe for use by consumers. These standards and

recommendations reflect the consensus of the scientific community and result from deliberations of panels and committees of scientists who continually review and interpret the extensive research literature.

In some situations or environments, the use of Wireless LAN may be restricted by the proprietor of the building or responsible representatives of the organization. These situations may for example include:

- ❖ Using the Wireless LAN equipment on board airplanes, or
- ❖ In any other environment where the risk of interference to other devices or services is perceived or identified as harmful.

If you are uncertain of the policy that applies on the use of wireless devices in a specific organization or environment (e.g. airports), you are encouraged to ask for authorization to use the Wireless LAN device prior to turning on the equipment.

CAUTION

Exposure to Radio Frequency Radiation

The radiated output power of the TOSHIBA Wireless LAN Mini PCI Card is far below the FCC radio frequency exposure limits. Nevertheless, the TOSHIBA Wireless LAN Mini PCI Card shall be used in such a manner that the potential for human contact during normal operation is minimized. In normal operating configuration, the LCD in the upright position, the distance between the antenna and the user should not be less than 20 cm. The antenna(s) used for this transmitter must not be co-located or operating in conjunction with any other antenna or transmitter. Antenna(s) used in 5.15 GHz to 5.25 GHz frequency band must be integral antenna which provide no access to the end user.

Refer to the Regulatory Statements as identified in the documentation that comes with those products for additional information.

Regulatory Information

The TOSHIBA Wireless LAN Mini PCI Card must be installed and used in strict accordance with the manufacturer's instructions as described in the user documentation that comes with the product. This device complies with the following radio frequency and safety standards.

Canada – Industry Canada (IC)

This device complies with RSS 210 of Industry Canada.

CAUTION

The installer of this radio equipment must ensure that the antenna is located or pointed such that it does not emit RF field in excess of Health Canada limits for the general population; consult Safety Code 6, obtainable from Health Canada's Web site www.hc-sc.gc.ca/rpb. The RF device shall not be co-located with any other transmitter that has not been tested with this device.

Operation is subject to the following two conditions: (1) this device may not cause interference, and (2) this device must accept any interference, including interference that may cause undesired operation of this device.

L'utilisation de ce dispositif est autorisée seulement aux conditions suivantes: (1) il ne doit pas produire de brouillage et (2) l'utilisateur du dispositif doit être prêt à accepter tout brouillage radioélectrique reçu, même si ce brouillage est susceptible de compromettre le fonctionnement du dispositif.

The term "IC" before the equipment certification number only signifies that the Industry Canada technical specifications were met.

To prevent radio interference to the licensed service, this device is intended to be operated indoors and away from windows to provide maximum shielding. Equipment (or its transmit antenna) that is installed outdoors is subject to licensing.

Pour empêcher que cet appareil cause du brouillage au service faisant l'objet d'une licence, il doit être utilisé à l'intérieur et devrait être placé loin des fenêtres afin de fournir un écran de blindage maximal. Si le matériel (ou son antenne d'émission) est installé à l'extérieur, il doit faire l'objet d'une licence.

CAUTION

This device is restricted to indoor use due to its operation in the 5.15 GHz to 5.25 GHz frequency range. Industry Canada requires this product to be used indoors for frequency range 5.15 GHz to 5.25 GHz to reduce the potential for harmful interference to co-channel Mobile Satellite systems.

High power radars are allocated as primary users of the 5.25 GHz to 5.35 GHz and 5.65 GHz to 5.85 GHz bands. These radar stations can cause interference with and/or damage this device.

EU Declaration of Conformity

TOSHIBA declares, that the product: PLU10* conforms to the following Standards:



Supplementary *The product complies with the
Information: requirements of the Low Voltage Directive
72/23/EEC, the EMC Directive 89/336/
EEC and/or the R&TTE Directive 1999/
05/EEC.

This product is carrying the CE-Mark in accordance with the related European Directives. Responsible for CE-Marking is TOSHIBA Europe, Hammfelddamm 8, 41460 Neuss, Germany.

VCCI Class B Information

この装置は、情報処理装置等電波障害自主規制協議会（VCCI）の基準に基づくクラスB情報技術装置です。この装置は、家庭環境で使用することを目的としていますが、この装置がラジオやテレビジョン受信機に近接して使用されると、受信障害を引き起こすことがあります。
取扱説明書に従って正しい取り扱いをして下さい。

Modem Warning Notice

Conformity Statement

The equipment has been approved to [Commission Decision “CTR-21”] for pan-European single terminal connection to the Public Switched Telephone Network (PSTN).

However, due to differences between the individual PSTNs provided in different countries/regions the approval does not, of itself, give an unconditional assurance of successful operation on every PSTN network termination point.

In the event of problems, you should contact your equipment supplier in the first instance.

NOTE The above Caution information applies to products that operate with an 802.11a device.

Taiwan

Article 14	Unless approved, for any model accredited low power radio frequency electric machinery, any company, trader or user shall not change the frequency, increase the power or change the features and functions of the original design.
Article 17	Any use of low power radio frequency electric machinery shall not affect aviation safety and interfere with legal communications. In the event interference is caused, the use of such electric machinery shall be immediately discontinued. Operation of such products can be resumed only when they are modified and can no longer cause interference.

The legal communications mentioned in the above item refer to radio communications operated in accordance with telecommunication laws and regulations.

Low power radio frequency electric machinery shall resist against interference from legal communications or from industrial, scientific and medical radio emission electric machinery.

Using this Equipment in Japan

In Japan, the frequency bandwidth of 2,400 MHz to 2,483.5 MHz for second generation low-power data communication systems such as this equipment overlaps that of mobile object identification systems (premises radio station and specified low-power radio station).

1. Sticker

Please put the following sticker on devices incorporating this product.

The frequency bandwidth of this equipment may operate within the same range as industrial devices, scientific devices, medical devices, microwave ovens, licensed radio stations and non-licensed specified low-power radio stations for mobile object identification systems (RFID) used in factory product lines (Other Radio Stations).

1. Before using this equipment, ensure that it does not interfere with any of the equipment listed above.
2. If this equipment causes RF interference to other radio stations, promptly change the frequency being used, change the location of use, or turn off the source of emissions.
3. Contact TOSHIBA Direct PC if you have problems with interference caused by this product to Other Radio Stations.

2. Indication

The indication shown below appears on this equipment.

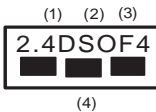

- 1 2.4: This equipment uses a frequency of 2.4 GHz.
- 2 DS: This equipment uses DS-SS modulation.
OF: This equipment uses OFDM modulation.
- 3 The interference range of this equipment is less than 40m.
- 4 ■■■ This equipment uses a frequency bandwidth from 2,400 MHz to 2,483.5 MHz.

It is possible to avoid the band of mobile object identification systems.

3. TOSHIBA Direct PC

Monday – Friday: 10:00 – 17:00

Toll Free Tel: 0120-13-1100

Direct Dial: 03-3457-5916

Fax: 03-5444-9450

Device Authorization

This device obtains the Technical Regulation Conformity Certification and the Technical Conditions Compliance Approval, and it belongs to the device class of radio equipment of low-power data communication system radio station stipulated in the Radio Law and the Telecommunications Business Law of Japan.

The Name of the radio equipment: refer to the equipment label provided on the computer

JAPAN APPROVALS INSTITUTE FOR TELECOMMUNICATIONS
EQUIPMENT

Approval Number: D01-1128JP

TELECOM ENGINEERING CENTER Approval Number: 03NY.A0018,
03GZDA0017

The following restrictions apply:

- ❖ Do not disassemble or modify the device.
- ❖ Do not install the embedded wireless module into other device.
- ❖ 5.17 GHz to 5.23 GHz for indoor use only.

Radio Approvals for Wireless Devices

NOTE The following information is dependent on what type of wireless device is in your computer.

Approved Countries/Regions for use for the Atheros AR5BMB-43/44 and AR5BMB5 Mini PCI Wireless Network Adapters

This equipment is approved to the radio standard by the countries/regions in the following table.

CAUTION Do not use this equipment except in the countries/regions in the following table.

NOTE This device works on passive scan only.
A peer-to-peer mode is not available in 802.11a and Turbo Mode.

802.11b (2.4 GHz)

Australia	Austria	Belgium
Canada	Denmark	Finland
France	Germany	Greece

Ireland	Italy	Liechtenstein
Luxembourg	Netherlands	New Zealand
Norway	Portugal	Sweden
Switzerland	UK	USA

Europe - Restrictions for use of 2.4 GHz Frequencies in European Community Countries

België/ Belgique:	For private usage outside buildings across public grounds over less than 300m no special registration with IBPT/BIPT is required. Registration to IBPT/BIPT is required for private usage outside buildings across public grounds over more than 300m. For registration and license please contact IBPT/BIPT.
	Voor privé-gebruik buiten gebouw over publieke grond over afstand kleiner dan 300m geen registratie bij BIPT/IBPT nodig; voor gebruik over afstand groter dan 300m is wel registratie bij BIPT/IBPT nodig. Voor registratie of licentie kunt u contact opnemen met BIPT.
	Dans le cas d'une utilisation privée, à l'extérieur d'un bâtiment, au-dessus d'un espace public, aucun enregistrement n'est nécessaire pour une distance de moins de 300m. Pour une distance supérieure à 300m un enregistrement auprès de l'IBPT est requise. Pour les enregistrements et licences, veuillez contacter l'IBPT.
Deutschland:	License required for outdoor installations. Check with reseller for procedure to follow.
	Anmeldung im Outdoor-Bereich notwendig, aber nicht genehmigungspflichtig. Bitte mit Händler die Vorgehensweise abstimmen.
France:	Restricted frequency band: only channels 1 to 7 (2400 MHz and 2454 MHz respectively) may be used outdoors in France. Please contact A.R.T. (http://www.art-telecom.fr) for applicable procedures to follow.
	Bande de fréquence restreinte: seuls les canaux 1- 7 (2400 et 2454 MHz respectivement) doivent être utilisés endroits extérieur en France. Vous pouvez contacter l'Autorité de Régulation des Télécommunications (http://www.art-telecom.fr) pour la procédure à suivre.
Italia:	License required for indoor use. Use with outdoor installations not allowed.
	E' necessaria la concessione ministeriale anche per l'uso interno. Verificare con i rivenditori la procedura da seguire.
Nederland:	License required for outdoor installations. Check with reseller for procedure to follow.
	Licentie verplicht voor gebruik met buitenantennes. Neem contact op met verkoper voor juiste procedure.

802.11a (5 GHz)

Australia	Austria	Belgium
Canada	Denmark	Finland
France	Germany	Greece
Ireland	Italy	Liechtenstein
Luxembourg	Netherlands	New Zealand
Norway	Portugal	Sweden
Switzerland	UK	USA

Turbo Mode (5 GHz)

Canada	USA	
--------	-----	--

Europe - Restrictions for Use of 5 GHz Frequencies in European Community Countries

European Community Countries	5150-5250 MHz	5250-5350 MHz	5470-5725 MHz
	Channels: 36, 40, 44, 48 Indoor Only	Channels: 52, 56, 60, 64 Indoor Only	Channels: 100, 104, 108, 112, 116, 120, 124, 128, 132, 136, 140 Indoor/Outdoor
Austria	O	x	x
Belgium, France, Switzerland/Lichtenstein	O	O	x
Denmark, Finland, Germany, Greece, Ireland, Italy, Luxembourg, Netherlands, Norway, Portugal, Sweden, UK	O	O	O
Iceland, Spain	O	O	O

O: allowed x: forbidden

- ❖ To remain in conformance with European spectrum usage laws for Wireless LAN operation, the above 2.4 GHz and 5 GHz channel limitations apply. The user should use the wireless LAN utility to check the current channel of operation. If operation is occurring outside of the allowable frequencies as listed above, the user must cease operating the Wireless LAN at that location and consult the local technical support staff responsible for the wireless network.
- ❖ The 5 GHz Turbo mode feature is not allowed for operation in any European Community country.
- ❖ This device must not be operated in ad-hoc mode using channels in the 5 GHz bands in the European Community. Ad-hoc mode provides a direct communication between two client devices without a Wireless LAN Access Point.

- ❖ This device must be used with Access Points that have employed and activated a radar detection feature required for European Community operation in the 5 GHz bands. This device will operate under the control of the Access Point in order to avoid operating on a channel occupied by any radar system in the area. The presence of nearby radar operation may result in temporary interruption of operation of this device. The Access Point's radar detection feature will automatically restart operation on a channel free of radar. You may consult with the local technical support staff responsible for the wireless network to ensure the Access Point device(s) are properly configured for European Community operation.

Approved Countries/Regions for use for the Atheros AR5001X Mini PCI Wireless Network Adapter

This equipment is approved to the radio standard by the countries/regions in the following table.

CAUTION Do not use this equipment except in the countries/regions in the following table.

NOTE This device works on passive scan only.
A peer-to-peer mode is not available in 802.11a and Turbo Mode.

802.11b (2.4 GHz)

Australia	Austria	Belgium
Canada	Denmark	Finland
France	Germany	Greece
Ireland	Italy	Liechtenstein
Luxembourg	Netherlands	New Zealand
Norway	Portugal	Sweden
Switzerland	UK	USA

802.11a (5 GHz)

Australia	Austria	Belgium
Canada	Denmark	Finland
France	Germany	Greece
Ireland	Italy	Liechtenstein
Luxembourg	Netherlands	New Zealand
Norway	Portugal	Sweden
Switzerland	UK	USA

Turbo Mode (5 GHz)

Canada	USA	
--------	-----	--

Approved Countries/Regions for use for the Intel® PRO/Wireless LAN 2100 3B Mini PCI Adapter

This equipment is approved to the radio standard by the countries/regions in the following table.

CAUTION Do not use this equipment except in the countries/regions in the following table.

Argentina	Australia	Austria
Belgium	Brazil	Canada
Chile	Denmark	Finland
France	Germany	Greece
Iceland	Ireland	Italy
Japan	Liechtenstein	Luxembourg
Mexico	Netherlands	New Zealand
Norway	Peru	Portugal
Singapore	Spain	Sweden
Switzerland	UK	Uruguay
USA	Venezuela	

Approved Countries/Regions for use for the Toshiba Mini PCI Wireless LAN Card

This equipment is approved to the radio standard by the countries/regions in the following table.

CAUTION Do not use this equipment except in the countries/regions in the following table.

Australia	Austria	Belgium
Canada	Denmark	Finland
France	Germany	Greece
Hong Kong	Iceland	Ireland
Italy	Japan	Liechtenstein
Luxembourg	Malaysia	Netherlands
New Zealand	Norway	Philippines
Portugal	Singapore	Spain
Sweden	Switzerland	Thailand
UK	USA	

Approved Countries/Regions for use for the INPROCOMM IPN2220 Wireless Network Adapter

This equipment is approved to the radio standard by the countries/regions in the following table.

CAUTION

Do not use this equipment except in the countries/regions in the following table.

EU	Canada	Japan
USA	Australia	New Zealand

Bluetooth® Wireless Technology Interoperability

Bluetooth® Cards from TOSHIBA are designed to be interoperable with any product with *Bluetooth* wireless technology that is based on Frequency Hopping Spread Spectrum (FHSS) radio technology, and is compliant to:

- ❖ *Bluetooth* Specification as defined and approved by The *Bluetooth* Special Interest Group.
- ❖ Logo certification with *Bluetooth* wireless technology as defined by The *Bluetooth* Special Interest Group.

CAUTION

Bluetooth wireless technology is a new innovative technology, and TOSHIBA has not confirmed compatibility of its *Bluetooth* products with all PCs and/or equipment using *Bluetooth* wireless technology other than TOSHIBA portable computers.

Always use *Bluetooth* cards from TOSHIBA in order to enable wireless networks over two or more (up to a total of seven) TOSHIBA portable computers using these cards. Please contact TOSHIBA PC product support on Web site <http://www.toshiba-europe.com/computers/tnt/bluetooth.htm> in Europe or pcsupport.toshiba.com in the United States for more information.

When you use *Bluetooth* cards from TOSHIBA close to 2.4 GHz Wireless LAN devices, *Bluetooth* transmissions might slow down or cause errors. If you detect certain interference while you use *Bluetooth* cards from TOSHIBA, always change the frequency, move your PC to the area outside of the interference range of 2.4 GHz Wireless LAN devices (40 meters/ 43.74 yards or more) or stop transmitting from your PC. Please contact TOSHIBA PC product support on Web site <http://www.toshiba-europe.com/computers/tnt/bluetooth.htm> in Europe or pcsupport.toshiba.com in the United States for more information.

Bluetooth and Wireless LAN devices operate within the same radio frequency range and may interfere with one another. If you use *Bluetooth* and Wireless LAN devices simultaneously, you may occasionally experience a less than optimal network performance or even lose your network connection. If you should experience any such problem, immediately turn off either one of your *Bluetooth* or Wireless LAN. Please contact Toshiba PC product support on Web site <http://www.toshiba-europe.com/computers/tnt/bluetooth.htm> in Europe or pcsupport.toshiba.com in the United States for more information.

Bluetooth® Wireless Technology and Your Health

The products with *Bluetooth*® wireless technology, like other radio devices, emit radio frequency electromagnetic energy. The level of energy emitted by devices with *Bluetooth* wireless technology however is far much less than the electromagnetic energy emitted by wireless devices like for example mobile phones.

Because products with *Bluetooth* wireless technology operate within the guidelines found in radio frequency safety standards and recommendations, TOSHIBA believes *Bluetooth* wireless technology is safe for use by consumers. These standards and recommendations reflect the consensus of the scientific community and result from deliberations of panels and committees of scientists who continually review and interpret the extensive research literature.

In some situations or environments, the use of *Bluetooth* wireless technology may be restricted by the proprietor of the building or responsible representatives of the organization. These situations may for example include:

- ❖ Using the equipment with *Bluetooth* wireless technology on board airplanes, or
- ❖ In any other environment where the risk of interference to other devices or services is perceived or identified as harmful.

If you are uncertain of the policy that applies on the use of wireless devices in a specific organization or environment (e.g. airports), you are encouraged to ask for authorization to use the device with *Bluetooth* wireless technology prior to turning on the equipment.

CAUTION

Exposure to Radio Frequency Radiation

The radiated output power of the *Bluetooth* Card from TOSHIBA is far below the FCC radio frequency exposure limits. Nevertheless, the *Bluetooth* Card from TOSHIBA shall be used in such a manner that the potential for human contact during normal operation is minimized.

In order to comply with FCC radio-frequency radiation exposure guidelines for an uncontrolled environment, the *Bluetooth* Card from TOSHIBA has to be operated while maintaining a minimum body to antenna distance of 20 cm.

Refer to the Regulatory Statements as identified in the documentation that comes with those products for additional information.

The *Bluetooth* Card from TOSHIBA is far below the FCC radio frequency exposure limits.

Nevertheless, it is advised to use the *Bluetooth* Card from TOSHIBA in such a manner that human contact during normal operation is minimized.

Regulatory statements

This product complies with any mandatory product specification in any country/region where the product is sold. In addition, the product complies with the following:

European Union (EU) and EFTA

This equipment complies with the R&TTE directive 1999/5/EC and has been provided with the CE mark accordingly.

Canada — Industry Canada (IC)

This device complies with RSS 210 of Industry Canada.

Taiwan

Article 14	Unless approved, for any model accredited low power radio frequency electric machinery, any company, trader or user shall not change the frequency, increase the power or change the features and functions of the original design.
Article 17	Any use of low power radio frequency electric machinery shall not affect aviation safety and interfere with legal communications. In the event interference is caused, the use of such electric machinery shall be immediately discontinued. Operation of such products can be resumed only when they are modified and can no longer cause interference.

The legal communications mentioned in the above item refer to radio communications operated in accordance with telecommunication laws and regulations.

Low power radio frequency electric machinery shall resist against interference from legal communications or from industrial, scientific and medical radio emission electric machinery.

Using this Equipment in Japan

In Japan, the frequency bandwidth of 2,400 MHz to 2,483.5 MHz for second generation low-power data communication systems such as this equipment overlaps that of mobile object identification systems (premises radio station and specified low-power radio station).

1. Sticker

Please put the following sticker on devices incorporating this product.

The frequency bandwidth of this equipment may operate within the same range as industrial devices, scientific devices, medical devices, microwave ovens, licensed radio stations and non-licensed specified low-power radio stations for mobile object identification systems (RFID) used in factory product lines (Other Radio Stations).

1. Before using this equipment, ensure that it does not interfere with any of the equipment listed above.
2. If this equipment causes RF interference to other radio stations, promptly change the frequency being used, change the location of use, or turn off the source of emissions.
3. Contact TOSHIBA Direct PC if you have problems with interference caused by this product to Other Radio Stations.

2. Indication

The indication shown below appears on this equipment.

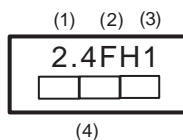

- 1 2.4: This equipment uses a frequency of 2.4 GHz.
- 2 FH: This equipment uses FH-SS modulation.
- 3 The interference range of this equipment is less than 10m.
- 4 This equipment uses a frequency bandwidth from 2,400 MHz to 2,483.5 MHz. It is impossible to avoid the band of mobile object identification systems.

3. TOSHIBA Direct PC

Monday – Friday: 10:00 – 17:00

Toll Free Tel: 0120-13-1100

Direct Dial: 03-3457-5916

Fax: 03-5444-9450

Device Authorization

This device obtains the Technical Regulation Conformity Certification, and it belongs to the device class of radio equipment of low-power data communication system radio station stipulated in the Radio Law of Japan.

The Name of the radio equipment: EYXF2CS

TELECOM ENGINEERING CENTER

Approval Number: 01NYDA1305

The following restrictions apply:

- ❖ Do not disassemble or modify the device.
- ❖ Do not install the embedded wireless module into other device.

Optical Drive Safety Instructions

⚠ DANGER

The DVD-ROM and multi-function drives employ a laser system. To ensure proper use of this product, please read this instruction manual carefully and retain for future reference.

Never attempt to disassemble, adjust or repair a CD/DVD drive, CD-RW drive, Multi-drive or any other optical drive. You could damage the drive. You would also be exposed to laser light or other safety hazards, resulting in serious injury. Always contact an authorized Toshiba service provider, if any repair or adjustment is required.

Location of the Required Label

(Sample shown below. Location of the label and manufacturing information may vary.)

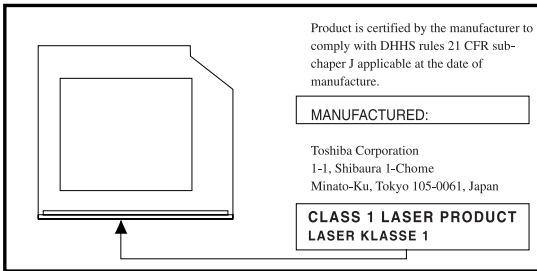

⚠ DANGER

This appliance contains a laser system and is classified as a CLASS 1 LASER PRODUCT. To use this model properly, read the user's guide carefully and keep it for your future reference.

Never attempt to disassemble, adjust or repair a CD/DVD drive, CD-RW drive, Multi-drive or any other optical drive. You could damage the drive. You would also be exposed to laser light or other safety hazards, resulting in serious injury. Always contact an authorized Toshiba service provider, if any repair or adjustment is required.



Copyright

This guide is copyrighted by Toshiba America Information Systems, Inc. with all rights reserved. Under the copyright laws, this guide cannot be reproduced in any form without the prior written permission of Toshiba. No patent liability is assumed, however, with respect to the use of the information contained herein.

©2006 by Toshiba America Information Systems, Inc. All rights reserved.

Export Administration Regulation

This document contains technical data that may be controlled under the U.S. Export Administration Regulations, and may be subject to the approval of the U.S. Department of Commerce prior to export. Any export, directly or indirectly, in contravention of the U.S. Export Administration Regulations is prohibited.

Notice

The information contained in this manual, including but not limited to any product specifications, is subject to change without notice.

TOSHIBA CORPORATION AND TOSHIBA AMERICA INFORMATION SYSTEMS, INC. (TOSHIBA) PROVIDES NO WARRANTY WITH REGARD TO THIS MANUAL OR ANY OTHER INFORMATION CONTAINED HEREIN AND HEREBY EXPRESSLY DISCLAIMS ANY IMPLIED WARRANTIES OF MERCHANTABILITY OR FITNESS FOR ANY PARTICULAR PURPOSE WITH REGARD TO ANY OF THE FOREGOING. TOSHIBA ASSUMES NO LIABILITY FOR ANY DAMAGES INCURRED DIRECTLY OR INDIRECTLY FROM ANY TECHNICAL OR TYPOGRAPHICAL ERRORS OR OMISSIONS CONTAINED HEREIN OR FOR DISCREPANCIES BETWEEN THE PRODUCT AND THE MANUAL. IN NO EVENT SHALL TOSHIBA BE LIABLE FOR ANY INCIDENTAL, CONSEQUENTIAL, SPECIAL, OR EXEMPLARY DAMAGES, WHETHER BASED ON TORT, CONTRACT OR OTHERWISE, ARISING OUT OF OR IN CONNECTION WITH THIS MANUAL OR ANY OTHER INFORMATION CONTAINED HEREIN OR THE USE THEREOF.

Trademarks

Satellite is a registered trademark of Toshiba America Information Systems, Inc. and/or Toshiba Corporation.

Microsoft and Windows are registered trademarks of Microsoft Corporation in the United States and/or other countries.

Direct3D, DirectSound, and DirectMusic are registered trademarks of Microsoft Corporation.

Wi-Fi is a registered trademark of the Wi-Fi Alliance.

Sound Blaster is a registered trademark of Creative Labs, Inc.

Dolby and the double-D symbol are trademarks of Dolby Laboratories.

Home Theater is a trademark of Dolby Laboratories.

Intel, Intel Core, Celeron, Centrino and Pentium are trademarks or registered trademarks of Intel Corporation or its subsidiaries in the United States and other countries.

TouchPad is a trademark of Synaptics, Inc.

Bluetooth word mark and logos are owned by the Bluetooth SIG, Inc. and any use of such marks by Toshiba is under license. Other trademarks and trade names are those of their respective owners.

All other brand and product names are trademarks or registered trademarks of their respective companies.

Computer Disposal Information

This product contains mercury. Disposal of this material may be regulated due to environmental considerations. For disposal, reuse or recycling information, please contact your local government or the Electronic Industries Alliance at www.eiae.org.

Introduction

Welcome to the world of powerful and portable multimedia computers!

Some software may differ from its retail version (if available), and may not include user manuals or all program functionality.

This guide

This guide offers important information about your computer, including solutions to the most common problems, and features and specifications.

For more detailed information, descriptions of other features, and more extensive troubleshooting guidelines, see the electronic user's guide preinstalled on your system. It is also available on the Web at pcsupport.toshiba.com.

Safety icons

This guide contains safety instructions that must be observed in order to avoid potential hazards that could result in personal injuries, damage to your equipment, or loss of data. These safety cautions have been classified according to the seriousness of the risk, and icons highlight these instructions as follows:

▲ DANGER

Indicates an imminently hazardous situation which, if not avoided, will result in death or serious injury.

▲ WARNING

Indicates a potentially hazardous situation which, if not avoided, could result in death or serious injury.

▲ CAUTION

Indicates a potentially hazardous situation which, if not avoided, may result in minor or moderate injury.

CAUTION

Indicates a potentially hazardous situation which, if not avoided, may result in property damage.

NOTE

Provides important information.

Other icons used

Additional icons highlight other helpful or educational information:



TECHNICAL NOTE: This icon highlights technical information about the computer.



HINT: This icon denotes helpful hints and tips.



DEFINITION: This icon indicates the definition of a term used in the text.

Other documentation

Your computer comes with the following documentation in addition to this resource guide:

- ❖ An electronic version of the user's guide.
- ❖ It may also contain guides for other programs that may come with your system.

For accessory information, visit Toshiba's Web site at accessories.toshiba.com.

Setting up your computer and getting started

The Toshiba Instruction Manual for Safety and Comfort, that shipped with your computer, contains helpful information for setting up your work environment and tips for working comfortably throughout the day.

Precautions

Your computer is designed to provide optimum safety and ease of use and to withstand the rigors of travel. You should observe certain precautions to further reduce the risk of personal injury or damage to the computer.

- ❖ Avoid prolonged physical contact with the underside or surface of the computer.

▲ WARNING Never allow any liquids to spill into any part of your computer, and never expose the computer to rain, water, seawater or moisture. Exposure to liquid or moisture can cause electric shock or fire, resulting in damage or serious injury. If any of these eventualities should accidentally occur, immediately:

1. Turn off the computer.
2. Disconnect the AC adapter from the power plug socket and computer.
3. Remove the battery pack.

Failure to follow these instructions could result in serious injury or permanent damage to the computer.

Do not turn on the power again until you have taken the computer to an authorized service center.

▲ WARNING If you experience discomfort while operating the computer, stop immediately and rest. Continuous operation for long periods without adequate rest may cause pain in the arms, wrists, hands, neck or other part of the body. If pain persists despite rest, consult your doctor.

▲ CAUTION PC base and palm rest can become hot! Avoid prolonged contact to prevent heat injury to skin.
Read the enclosed Instruction Manual for Safety and Comfort.

▲ CAUTION Some PC Cards can become hot with prolonged use. Overheating of a PC Card can result in errors or instability in its operation.
Before you remove a PC Card, always wait for it to cool. You could get burned removing a hot PC Card.

CAUTION Never place a heavy object on the computer and be careful not to drop a heavy object onto the computer. It could damage the computer or cause system failure.

Your computer's features and specifications

Certain notebook chassis are designed to accommodate all possible configurations for an entire product Series. Your select model may not have all the features and specifications corresponding to all of the icons or switches shown on the notebook chassis, unless you have selected all those features.

This information applies to all the features and icons described in this guide.

Below are examples of some of the many possible icons used on your computer:



Sample system icons

Connecting to a power source

Your computer requires power to operate. Use the power cord/cable and AC adapter to connect the computer to a live electrical outlet, or to charge the computer's battery.

▲ WARNING

Never pull on a power cord/cable to remove a plug from a socket. Always grasp the plug directly. Failure to follow this instruction may damage the cord/cable, and/or result in a fire or electric shock, possibly resulting in serious injury.

▲ WARNING

When you connect the AC adapter to the computer, always follow the steps in the exact order as described in the User's Guide. Connecting the power cord/cable to a live electrical outlet should be the last step; otherwise, the adapter DC output plug could hold an electrical charge and cause an electrical shock or minor bodily injury when touched. As a general safety precaution, avoid touching any metal parts.

▲ CAUTION

Always use the Toshiba AC adapter that was provided with your computer, or use Toshiba recommended alternate models to avoid any risk of fire or other damage to the computer. Use of an incompatible AC adapter could cause fire or damage to the computer, possibly resulting in serious injury.

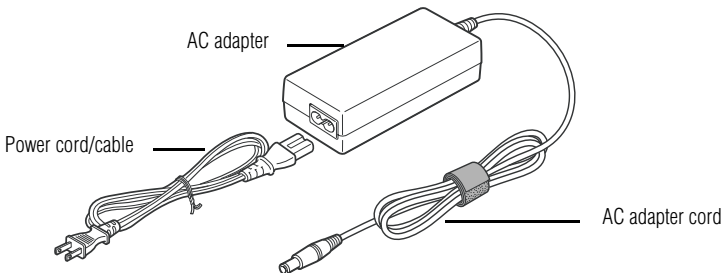

Sample power cord/cable and AC adapter

To connect AC power to the computer:

- 1 Connect the power cord/cable to the AC adapter.

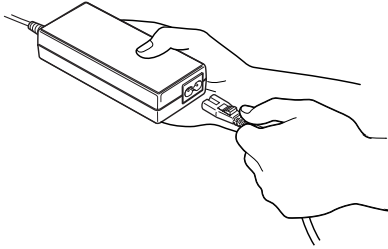

Sample connecting the power cord/cable to the AC adapter

▲ WARNING Handling the cord on this product will expose you to lead, a chemical known to the State of California to cause birth defects or other reproductive harm. **Wash hands after handling.**

-  2 Plug the AC adapter into the DC-IN on the back of the computer.

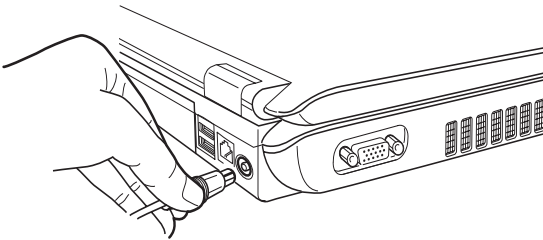

Sample connecting the AC adapter to the computer

-  3 Connect the power cord/cable to a live electrical outlet.
The AC power and battery lights on the indicator panel glow blue.

▲ WARNING Never tamper with the cord/cable or plug; never splice or alter a cord/cable; never bend or twist a cord/cable; never place heavy objects on a cord/cable; never place a cord/cable near a heat source; never run a cord/cable through a pinch point such as a door or window; never use nails, staples or similar objects to fasten or attach cord in place; never attempt to disassemble or repair an AC adapter or a Battery Charger. Doing any of the above may damage the cables, and/or result in a fire or electric shock, possibly resulting in serious injury.

▲ WARNING

Never attempt to connect or disconnect a power plug with wet hands. Failure to follow this instruction could result in an electric shock, possibly resulting in serious injury.

Connecting a printer

NOTE

Your printer documentation may require you to install the printer software before physically connecting the printer to your computer. If you do not install the software as instructed by the printer manufacturer, the printer may not function correctly.

Read the documentation that came with your printer. Follow the manufacturer's instructions when connecting a printer.

You can connect a USB-compatible printer to your computer through one of the USB ports. To determine if the printer is USB-compatible, check its documentation.

To make the connection, you need a suitable USB cable, which may come with your printer. If a USB cable was not included with your printer, you can purchase one from a computer or electronics store.

If your printer supports Plug and Play, your computer will automatically recognize the printer; the printer is then ready for use. Refer to your printer documentation for further instructions.



TECHNICAL NOTE: To determine if your printer supports Plug and Play, check its documentation.

If your printer does not support Plug and Play, you must set up the printer as described in “Setting up a printer” in the electronic user’s guide.

To connect a USB printer to your computer:



- 1 Connect the printer cable to the printer and then connect the other end to one of the computer’s USB ports.
- 2 Plug the printer’s power cable into a live electrical outlet.

See your printer documentation for additional configuration steps, or see “Setting up a printer” in the electronic user’s guide.

Installing additional memory (optional)



HINT: To purchase additional memory modules, see the accessories information packaged with your system or visit accessories.toshiba.com.

Your computer comes with enough memory to run most of today's popular applications. You may want to increase the computer's memory if you use complex software or process large amounts of data.

For more information on memory options, check the accessories information that came with your computer, or visit accessories.toshiba.com.

Additional memory modules can be installed in the memory module slots on the base of the computer. You will need a standard Phillips No. 1 screwdriver for this procedure.

CAUTION If you use the computer for a long time, the memory module will become hot. If this happens, let the module cool to room temperature before you replace it.

CAUTION To avoid damaging the computer's screws, use a standard Phillips No. 1 screwdriver that is in good condition.

CAUTION Installing a memory module with the computer's power on may damage the computer, the module, or both.

The computer has two memory module slots — Slot A and Slot B. You can install one or two memory modules.

CAUTION Before you install or remove a memory module, turn off the computer using the Start menu. If you install or remove a memory module while the computer is in Standby or Hibernation mode, data will be lost.

If the computer is on, begin at step 1; otherwise, skip to step 3.

- 1 Click **Start**, then **Turn off computer** or **Shut Down** (depending on the system).

The Turn off computer or Shut Down window appears.

- 2 Click **Turn Off** or **Shut Down**.

The operating system turns off the computer.

- 3 Unplug and remove any cables connected to the computer, including the AC adapter.
- 4 Remove the main battery. For information on removing the main battery, see “Removing the battery from the computer” on page 46).
- 5 Close the display panel and turn the computer upside down to locate the memory module slot cover.

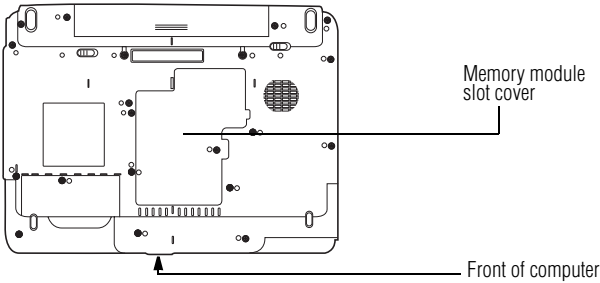

Sample locating the memory module slot cover

- 6 Using a standard Phillips No. 1 screwdriver, unscrew the screw that secures the memory module slot cover.

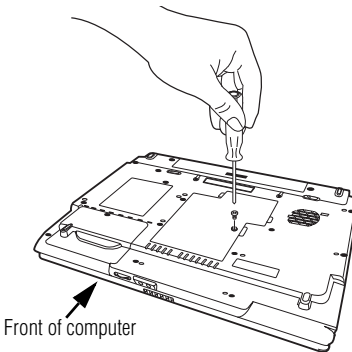

Sample unscrewing the memory module slot cover

- 7 Remove the memory module slot cover.
- 8 Place the screw and the cover in a safe place so that you can retrieve them later.

CAUTION

Static electricity can damage the memory module. Before you handle the module, touch a grounded metal surface to discharge any static electricity you may have built up.

To avoid damaging the memory module, be careful not to touch its pin connector on the side you insert into the computer.

- 9 Remove the new memory module from its antistatic packaging.

CAUTION

Avoid touching the connectors on the memory module or on the computer. Grease or dust on the connectors may cause memory access problems.

- 10 Insert the memory module into the socket on the underside of the computer.
- 11 Hold the memory module by its edges so that the gold connector bar faces the slot, at approximately a 45-degree angle to the socket.

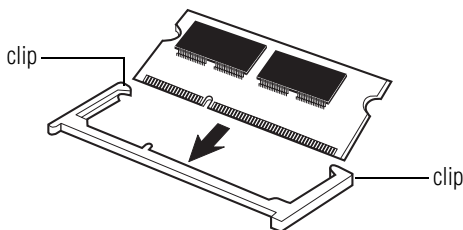

Sample inserting the memory module into the socket

- 12 Check that the module is inserted completely into the socket and lined up squarely with the socket clips.

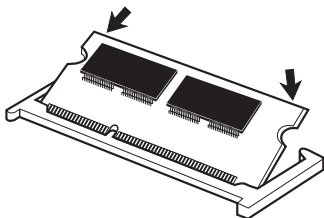

Sample aligning the module into the socket

- 13 Gently press down on the memory module connector until the clips snap into place.

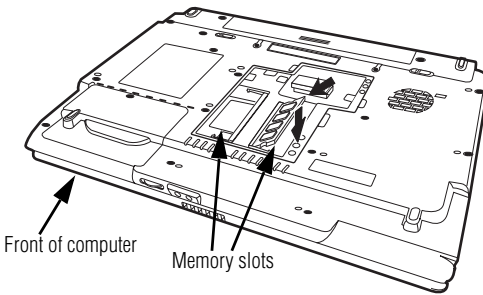

Sample inserting the memory module into the slot

Do not force the memory module into position. The memory module should be completely inserted into the socket and level when secured in place.

The clips on either side of the memory module snap into place when the memory module is properly inserted.

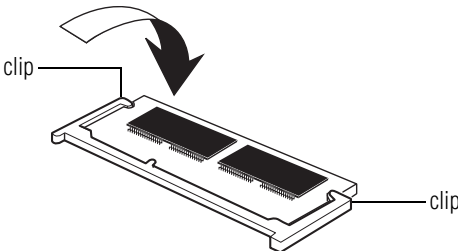

Sample pressing down on the memory module

- 14 Replace the memory module slot cover and tighten the screw.
- 15 Re-insert the main battery. For information on inserting the main battery, see “Inserting a charged battery” on page 47.
- 16 Turn the computer right side up.
- 17 Reconnect the cables.
- 18 Restart the computer.



TECHNICAL NOTE: You must have at least one memory module installed for the computer to work.

Removing a memory module

If you need to remove a memory module:

- 1 Complete steps 1-8 in “Installing additional memory (optional)” on page 31 to shut down the computer and open the memory module slot cover.

CAUTION

Do not try to remove a memory module with the computer turned on. You can damage the computer and the memory module.

Do not remove the memory module while the computer is in Standby or Hibernation mode. The computer could hang up the next time you turn it on and data in memory will be lost. In either of the above cases, the Standby configuration will not be saved.

The following message appears when you turn on the power:

Warning: Resume Failure
Press Any key to Continue

If the computer hangs up when you turn it on, perform the following: Press the power button and hold it down for at least ten seconds, then turn the power on again.

- 2 Pull the clips away from the memory module.
The memory module pops up slightly.
- 3 Gently lift the memory module to a 45-degree angle and slide it out of the slot.
- 4 Replace the memory module slot cover and tighten the screw.
- 5 Re-insert the main battery. For information on inserting the main battery, see “Inserting a charged battery” on page 47.
- 6 Turn the computer right side up.
- 7 Reconnect the cables.
- 8 Restart the computer.



TECHNICAL NOTE: You must have at least one memory module installed for the computer to work.

Your computer's TFT display

Small bright dots may appear on your screen display when you turn on your PC. Your display contains an extremely large number of thin-film transistors (TFT) and is manufactured using high-precision technology. Any small bright dots that may appear on your display are an intrinsic characteristic of the TFT manufacturing technology. Over a period of time, and depending on the usage of the computer, the brightness of the screen will deteriorate. This is also an intrinsic characteristic of the screen technology. When the computer is operated on battery power, the screen will dim and you may not be able to increase the brightness of the screen while on battery power.

Inserting a PC Card

Before you insert a PC Card, refer to the documentation that comes with the card to see if you need to do anything before you insert it.

You may insert one Type I or Type II card into the computer's PC Card slot.

To insert a PC Card:

- 1 Locate the PC Card slot on the left side of the computer.
- 2 Insert the PC Card into the slot.

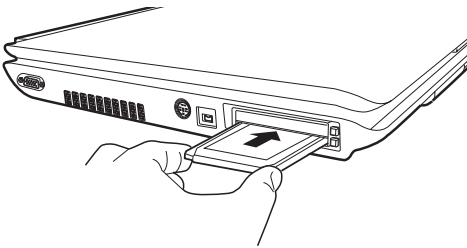

Sample inserting a PC Card

- 3 When the card is almost all the way into the slot, push firmly but gently to ensure a firm connection with the computer. Do not force the card into position.

Removing a PC Card



Prepare the card for removal by right-clicking on the **Safely Remove Hardware** icon on the system tray and then selecting the PC Card device.

If the card can be removed now, the system displays **Safe To Remove Hardware**.

- 1 Locate the PC Card eject button next to the PC Card slot.
- 2 Press the PC Card eject button once to pop it out slightly, then push it in to remove the PC Card.

The PC Card ejects slightly from the slot.

- 3 Grasp the edges of the PC Card and slide it out of the slot.

Learning the basics

Computing tips

- ❖ Save your work frequently.

Your work stays in the computer's temporary memory until you save it to the disk. If the network you are using goes down and you must restart your computer to reconnect, or your battery runs out of charge while you are working, you will lose all work since you last saved.



HINT: Some programs have an automatic save feature that you can turn on. This feature saves your file to the hard disk at preset intervals. See your software documentation for details.

- ❖ Back up your files to a removable storage media on a regular basis. Label the backup copies clearly and store them in a safe place.
- ❖ Scan all new files for viruses.
- ❖ Do not turn off the computer if a drive indicator light indicates a drive is active.

NOTE

The Windows® operating system records information, such as your desktop setup, during its shutdown procedure. If you do not let the Windows® operating system shut down normally, details such as new icon positions may be lost.

Using the TouchPad™/Dual Mode Pad

The TouchPad/Dual Mode Pad, the small, smooth, square cutout located in front of the keyboard, is sensitive to touch and enables you to move the cursor with the stroke of a finger. Simply move your finger on the TouchPad/Dual Mode Pad in the direction you would like to move the cursor:

- ❖ To move the cursor to the top of the page, push your finger forward on the TouchPad/Dual Mode Pad.
- ❖ To move the cursor to the bottom of the page, drag your finger toward yourself.
- ❖ To move the cursor to the right side of the page, slide your finger across the TouchPad/Dual Mode Pad from left to right.
- ❖ To move it to the left side, slide your finger from right to left.

NOTE

Because the TouchPad/Dual Mode Pad is much smaller than the display screen, moving your cursor across the screen often means having to move your finger several times across the TouchPad/Dual Mode Pad in the preferred direction.

Once you have positioned your cursor, you can click it into place by either double-tapping the TouchPad/Dual Mode Pad or clicking the control buttons.

Scrolling with the TouchPad™/Dual Mode Pad

There are two active regions on the TouchPad/Dual Mode Pad that allow you to scroll as you would with any wheel device on a mouse or trackball.

To scroll vertically, run your finger up or down along the right edge of the TouchPad/Dual Mode Pad. To scroll horizontally, run your finger along the bottom edge of the TouchPad/Dual Mode Pad. This feature can be disabled or changed in the Mouse Properties dialog box.

Control buttons

When a step instructs you to click or choose an item, move the cursor to the item, then press and release the primary (left-hand) button. To double-click, press the primary button twice in rapid succession. The primary button usually corresponds to the left mouse button.

The function of the secondary (right-hand) button depends on the program you are using. It usually corresponds to the right mouse button. Check your program's documentation to find whether it uses the right mouse button.

Using the Optical drive

Optical storage has become the preferred medium for software, music, and video. Digital versatile discs (DVDs) provide a significant increase in data storage and support features that are not available on any other video platform. These features include wide-screen movies, multiple language tracks, digital surround sound, multiple camera angles, and interactive menus.

For these reasons, your computer may come with an Optical drive.



TECHNICAL NOTE: Your Optical drive is set to play region 1 (North America) DVD-ROMs. If you play a DVD disc from another region, the drive will automatically change to play in the format of the other region. The drive will allow you to change regions four times. On the fourth change, the region will be "locked in." That is, the drive will only play DVDs from that last region. Note that changing from region 1 to region 2 and back to region 1 is counted as two changes.

NOTE

For optimum DVD performance, it is recommended that you play DVDs while running the computer on AC power.

Your Optical drive may look like this:

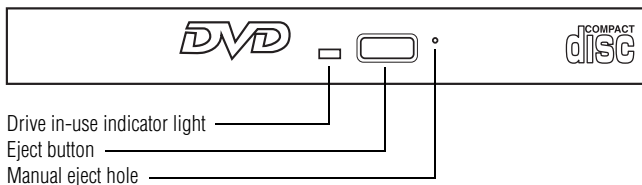

Sample Optical drive

Drive in-use indicator light—Indicates when the drive is in use.

Eject button—Press to release the disc tray.

CAUTION

Do not press the eject button or turn off the computer while the drive in-use indicator light is glowing. Doing so could damage the disc or the drive.

When the disc tray is open, be careful not to touch the lens or the area around it. Doing so could cause the drive to malfunction.

Manual eject hole—Use if you need to release the disc tray when the power is off. Use a straightened paper clip or other narrow object to press the manual eject button located inside the hole.

CAUTION

Never use a pencil to press the manual eject button. Pencil lead can break off inside the computer and damage it.

CD/DVD control buttons

The CD/DVD control buttons located to the left of the keyboard let you access the Internet when the computer is on and play audio CDs or DVD movies when the computer is off. You can also use them to play CDs and DVDs when the computer is on.

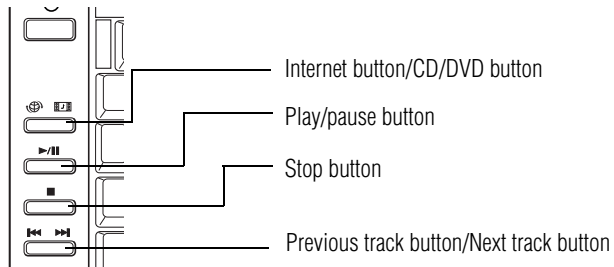

Sample CD/DVD control buttons

The **Internet button/CD/DVD button** lets you access the Internet when the computer is powered on or activates a media playing application that can play audio CDs or DVD movies when the computer is powered off.

The following chart describes the Internet button/CD/DVD button functionality.

Power is off or the computer is in Hibernation mode and you press the left side of the Internet button/CD/DVD button	The system accesses the Internet.
Operating system is running or the computer is in Standby mode and you press the left side of the Internet button/CD/DVD button	The system accesses the Internet.
Power is off or the computer is in Hibernation mode and you press the right side of the Internet button/CD/DVD button	If a CD is in the drive, the system operates as a stand-alone CD player. If a DVD is in the drive, the system operates as a stand-alone DVD movie player
Operating system is running or the computer is in Standby mode and you press the right side of the Internet button/CD/DVD button	If a CD is in the drive, the Windows Media® Player starts and the audio CD begins to play. If a DVD is in the drive, WinDVD™ starts and the DVD begins to play.

The **previous track button/next track button** returns to the preceding track on the disc (press the left side of the button) or skips to the following track on the disc (press the right side of the button).

The **play/pause button** starts playing the disc or makes it pause if currently playing.

The **stop** button stops a disc that is currently playing.

Inserting a compact disc

CAUTION

Before putting on headphones to listen to an audio CD, turn the volume dial down. Do not set the volume too high when using the headphones. Continuous exposure to loud sound can harm your hearing.

To insert a compact disc into the drive:

- 1 Make sure the computer is turned on.
- 2 Make sure the drive's in-use indicator light is off.
- 3 Press the drive's eject button.

The disc tray slides partially out of the drive (about 1 inch).



HINT: The drive will not open if the computer's power is off.

- 4 Grasp the tray and pull it fully open.
- 5 Hold the disc by its edges and check that it is free of dust.
If the disc is dusty, clean it.
- 6 Place the disc carefully in the disc tray, label side up.

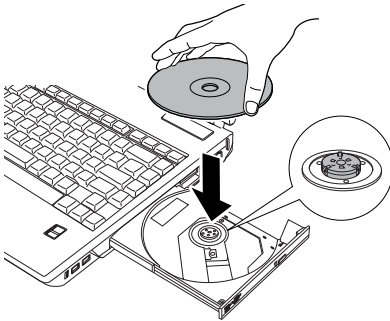

Sample positioning the disc in the drive

- 7 Gently press the disc onto the center spindle until it clicks into place.

CAUTION

Handle DVDs and CDs carefully, making contact only with the center hole and edge. Do not touch the surface of the disc. Do not stack discs. If you incorrectly handle the discs, you could lose data.

-
- 8 Make sure the disc is completely on the spindle and is lying flat on the tray.

CAUTION If you insert the disc incorrectly, it may jam the drive. If this happens, contact Toshiba support for assistance.

- 9 Push the disc tray in by pressing gently on the center of the tray until it clicks into place.

You are ready to use the disc.

Removing a disc with the computer on

To remove a compact disc (CD or DVD) with the computer turned on:

- 1 Press the eject button on the drive.

CAUTION Do not press the eject button while the in-use indicator light is glowing. Doing so could damage the disc or the drive.

Also, if the disc is still spinning when you open the disc tray, wait for it to stop spinning before you remove it.

- 2 Pull the tray out until it is fully open, remove the disc, and place it in its protective cover.
- 3 Gently push the tray in to close it.

Removing a disc with the computer off

- 1 Insert a slender object, such as a straightened paper clip, into the manual eject hole.

The disc tray slides partially out of the drive (about 1 inch).

CAUTION Never use a pencil to press the manual eject button. Pencil lead can break off inside the computer and damage it.

- 2 Pull the tray out until it is fully open, remove the disc, and place it in its protective cover.
- 3 Gently push the tray in to close it.

Moving the computer

Before moving your computer, even across the room, make sure all disk activity has ended (the drive indicator light stops glowing) and all external peripheral cables are disconnected.

CAUTION

Do not pick up the computer by its display panel or by the back (where the ports are located). Doing so could damage the system.

Mobile computing

Running the computer on battery power

Battery life may vary considerably from specifications depending on product model, configuration, applications, power management settings and features utilized, as well as the natural performance variations produced by the design of individual components. Published battery life numbers are achieved on select models and configurations tested by Toshiba at the time of publication. Recharge time varies depending on usage. Battery may not charge while the computer is consuming full power.

After a period of time, the battery will lose its ability to perform at maximum capacity and will need to be replaced. This is normal for all batteries. To purchase a new battery pack, see the accessories information that shipped with your computer or visit the Toshiba Web site at accessories.toshiba.com.

To ensure that the battery maintains its maximum capacity, operate the computer on battery power at least once a month until the battery is fully discharged. Please see “Maximizing battery life” on page 49 for procedures. If the computer is continuously operated on AC power, either through an AC adapter or a docking station (if applicable to your system), for an extended period (more than a month), the battery may fail to retain a charge. This may shorten the life of the battery, and the battery light may not indicate a low-battery condition.

The computer also has an internal real-time-clock (RTC) battery.

The RTC battery powers the RTC memory that stores your system configuration settings and the current time and date information. It maintains this information for up to a month while the computer is turned off.



TECHNICAL NOTE: The RTC battery does not charge while the computer is turned off, even when AC power is attached.

The RTC battery charges only while the computer is powered on.

Monitoring battery power



The computer's main battery light gives you an indication of the main battery's current charge:



- ❖ Glows amber while the main battery is being charged (AC adapter connected).
- ❖ Glows blue when the main battery is fully charged.
- ❖ Is unlit when the battery has discharged, the battery is not charging, or the AC adapter is not plugged into the computer or AC outlet.

NOTE

Battery life and charge time may vary, depending upon power management settings, applications and features used.

- ❖ Flashes amber when the main battery charge is low and it is time to recharge the main battery or plug in the AC adapter.



HINT: Be careful not to confuse the battery light () with the on/off light (). When the on/off light flashes amber, it indicates that the system is suspended (using the Windows® operating system Standby command).



TECHNICAL NOTE: When your computer is using all of the power provided by the AC Adapter to run applications, features, and devices, the recharging of the battery cannot occur. Your computer's Power Saver utility can be used to select a power level setting that reduces the power required for system operation and will allow the battery to recharge.

Setting battery alarms

Your computer can be configured to warn you when the battery is running low. For more information, see “Setting battery alarms” in the electronic user’s guide.

Changing the main battery

When your main battery has run out of power, you have two options: plug in the AC adapter or install a fresh main battery.

▲ WARNING

Never short circuit the battery pack by either accidentally or intentionally bringing the battery terminals in contact with another conductive object. This could cause serious injury or fire, and could also damage the battery pack.

▲ WARNING

Never expose a battery pack to abnormal shock, vibration or pressure. The battery pack’s internal protective device could fail, causing it to overheat or ignite, resulting in caustic liquid leakage, or explosion or fire, possibly resulting in death or serious injury.



TECHNICAL NOTE: To avoid losing any data, save your files and then either completely shut down your computer, or put it into Hibernation mode before changing the main battery.

Removing the battery from the computer

To remove the battery:

- 1 Save your work.
- 2 Turn off the computer or place it in Hibernation mode according to the instructions in “Using and configuring Hibernation mode” in the electronic user’s guide.
- 3 Unplug and remove any cables connected to the computer, including the AC adapter.
- 4 Close the display panel and turn the computer upside down.

- 5 Slide the battery release lock to the unlocked position.

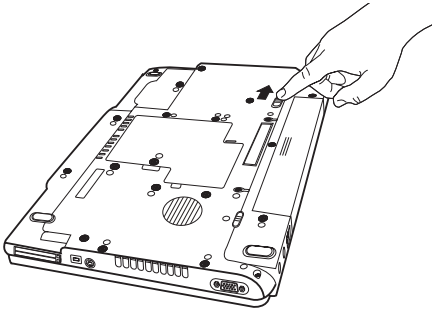

Sample unlocking the battery release lock

- 6 Slide the battery release latch to release the battery.
- 7 Pull the discharged battery out of the computer.

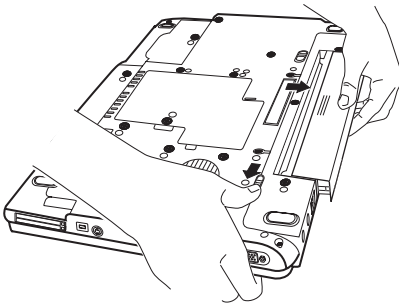

Sample removing the battery

▲ WARNING

If the battery is leaking or its case is cracked, put on protective gloves to handle it, and discard it immediately. Always dispose of used battery packs in compliance with all applicable laws and regulations. Put insulating tape, such as cellophane tape, on the electrode during transportation to avoid a possible short circuit, fire or electric shock. Failure to do so could possibly result in serious injury.

Inserting a charged battery

To insert a battery:

- 1 Wipe the terminals of the charged battery with a clean cloth to ensure a good connection.

- 2 Insert the charged battery into the slot until the latch clicks. The battery has been designed so that you cannot install it with reverse polarity.

CAUTION

If the battery does not slide into the slot easily, move the battery release lock to the unlocked position and try again. Do not force the battery into position.

- 3 Slide the battery lock to the locked position.
- 4 Turn the computer right side up.
- 5 Reconnect any cables that were removed in step 3 of “Removing the battery from the computer” on page 46.
- 6 Restart the computer.

Taking care of your battery

The following sections offer tips on how to take care of your battery and prolong its life.

Battery safety precautions

- ❖ If the battery pack produces an odor, overheats or changes color or shape while it is being used or charged, turn off the computer’s power immediately and disconnect the power cord/cable from the power socket. Carefully remove the battery pack from the computer.
- ❖ Do not try to disassemble a battery pack.
- ❖ Do not overcharge or reverse charge a battery. Overcharging will shorten its life, and reverse charging could damage it.
- ❖ Avoid touching the metal terminals of the battery with another metal object. Short-circuiting the battery can cause it to overheat and may cause damage to the battery or the computer.
- ❖ Do not incinerate a spent battery, as this could cause it to explode and release caustic liquid.
- ❖ If a battery is leaking or damaged, replace it immediately. Use protective gloves when handling a damaged battery.

- ❖ To replace the main battery, use an identical battery that you can purchase through the Toshiba Web site at accessories.toshiba.com.
- ❖ A reverse polarity condition should be avoided with all batteries. The main battery is designed so that it cannot be installed in reverse polarity.
- ❖ Charge the battery only in the computer or in a battery charger designated as an approved option.
- ❖ When you install the battery pack, you should hear a click when it is seated properly.
- ❖ Do not expose the battery pack to fire. The battery pack could explode.

Maximizing battery life

To maximize the life of your battery pack:

- ❖ At least once a month, disconnect the computer from a power source and operate it on battery power until the battery pack fully discharges. Before doing so, follow the steps below:
 - 1 Turn off the computer's power.
 - 2 Disconnect the AC adapter and turn on the computer's power. If it does not turn on, go to step 4.
 - 3 Operate the computer on battery power for five minutes. If the battery pack has at least five minutes of operating time, continue operating until the battery pack is fully discharged. If the battery light flashes or there is some other warning to indicate a low battery, go to step 4.
 - 4 Connect the AC adapter to the computer and connect the power cord/cable to a power outlet. The DC-IN or AC power-light should glow blue, and the battery light should glow amber to indicate that the battery pack is being charged. If the DC-IN or AC power-light indicator does not glow, power is not being supplied. Check the connections for the AC adapter and power cord/cable.
 - 5 Charge the battery pack until the battery light glows blue.
- ❖ If you have extra battery packs, rotate their use.

- ❖ If you will not be using the system for an extended period, more than one month, remove the battery pack.
- ❖ Disconnect the AC adapter when the battery is fully charged. Overcharging makes the battery hot and shortens its life.
- ❖ If you are not going to use the computer for more than eight hours, disconnect the AC adapter.
- ❖ Store spare battery packs in a cool dry place out of direct sunlight.

Disposing of used batteries

When a battery pack nears the end of its life, its ability to hold a charge will decrease. When the battery pack needs to be replaced, the main battery light flashes amber shortly after you have fully recharged the battery.

You must discard a battery if it becomes damaged.

▲ WARNING Never attempt to dispose of a battery pack by burning or by throwing it into a fire, and never allow exposure to a heating apparatus (e.g., microwave oven). Heat can cause a battery pack to explode and possibly cause serious injury.

Always dispose of used battery packs in compliance with all applicable laws and regulations. Put insulating tape, such as cellophane tape, on the electrode during transportation to avoid a possible short circuit, fire or electric shock. Failure to do so could possibly result in serious injury.

▲ WARNING Always use the battery pack supplied as an accessory or an equivalent battery pack specified in the User's Manual. Other battery packs have different voltage and terminal polarities. Use of non-conforming battery packs could generate smoke or cause fire or rupture, possibly resulting in serious injury.

After repeated use, batteries will finally lose their ability to hold a charge and you will need to replace them. Under certain applicable laws, it may be illegal to dispose of old batteries by placing them in the trash.

Please be kind to our shared environment. Check with your local government authority for details regarding where to recycle old batteries or how to dispose of them properly. If you cannot find the information you need elsewhere, call Toshiba at: (800) 457-7777.

If something goes wrong

Problems that are easy to fix

Your program stops responding.

If you are working with a program that suddenly freezes all operations, chances are the program has stopped responding. You can exit the failed program without shutting down the operating system or closing other programs.

To close a program that has stopped responding:

- 1 Press **Ctrl, Alt, and Del** simultaneously (once).

The Windows Task Manager window appears.

- 2 Click the **Applications** tab.

If a program has stopped responding, the words “not responding” appear beside its name in the list.

- 3 Select the program you want to close, then click **End Task**.

Closing the failed program should allow you to continue working. If it does not, continue with the next step.

- 4 Close the remaining programs one by one by selecting the program name, then **End Task**.

To power off your computer, do one of the following:

If you are not connected to a domain server:

- 1 Click **Start, Turn off computer**.

The Turn off computer window appears.

- 2 Click **Turn Off**.

The computer turns off.

If you are connected to a domain server:

- 1 Click **Start, Shut down**.

The Shut Down window appears.

- 2 Click **Shut down** from the drop-down list.
- 3 Click **OK**.

The computer shuts down completely.

Your program performs an illegal operation.

If you receive the message, “Your program has performed an illegal operation,” close the window and continue working. If it happens again, record the details of the message and consult the software manufacturer.

To record the details:

- 1 Click the **Details** button and select the text the operating system displays.

The Details button displays information that the software manufacturer needs to help you solve your problem.

- 2 Press Ctrl and c simultaneously to copy the text to the clipboard.
- 3 Open Notepad (click **Start, All Programs, Accessories** and then click **Notepad**).
- 4 Press Ctrl and v simultaneously to paste the details into Notepad.
- 5 Add a paragraph break and type some notes describing what you were doing when you received the message and how the error can be reproduced.
- 6 Save the file and refer to it when you contact the software manufacturer.

Problems when you turn on the computer

These problems may occur when you turn on the power.

The computer will not start.

Make sure you attached the AC adapter and power cord/cable properly or installed a charged battery.

Press and hold the power switch for at least 10 seconds.

If you are using the AC adapter, check that the wall outlet is working by plugging in another device, such as a lamp.

Verify that the computer is on by looking at the on/off indicator. If the indicator is glowing, the computer is on.

If you are using an AC adapter, verify that the computer is receiving power from the external power source by looking at the AC power light. If the indicator is glowing, the computer is connected to a live external power source.

The computer starts, but when you press a key nothing happens.

Verify that the active program accepts text input. Try clicking your mouse on an area where you can type text and try typing again.

Your computer may be in Standby mode and have a software or resource conflict. When this happens turning the power on returns you to the problem instead of restarting the system. To clear the condition, press Ctrl, Alt, and Del simultaneously.

Clearing the condition may get the computer running, but it will not solve a resource conflict. Read the documentation that came with the conflicting device and “Resolving a hardware conflict” in your electronic user’s guide.

The keyboard produces unexpected characters.

A keypad overlay may be on. If the numlock light or cursor control mode light is on, press Fn and F10 simultaneously to turn off the cursor control mode light or Fn and F11 simultaneously to turn off the numlock light.

If the problem occurs when both the keypad overlays are off, make sure the software you are using is not remapping the keyboard. Refer to the software documentation and check that the program does not assign different meanings to any of the keys.

Display problems

Here are some typical display problems and their solutions:

The screen is blank.

Display Auto Off may have gone into effect. Press any key to activate the screen.

You may have activated the instant password feature by pressing Fn and F1 simultaneously. If you have registered a password, press any key, type the password and press Enter. If no password is registered, press any key. The screen reactivates and allows you to continue working.

If you are using the built-in screen, make sure the display priority is not set for an external monitor. To do this, press Fn and F5 simultaneously (once). If this does not correct the problem, press Fn and F5 simultaneously again to return the display priority to its previous setting.



HINT: Holding the Fn key and pressing the F5 key several times will advance you through the display options.

If you are using an external monitor:

- ❖ Check that the monitor is turned on.
- ❖ Check that the monitor's power cord/cable is firmly plugged into a working power outlet.
- ❖ Check that the cable connecting the external monitor to the computer is firmly attached.
- ❖ Try adjusting the contrast and brightness controls on the external monitor.
- ❖ Press Fn and F5 simultaneously to make sure the display priority is not set for the built-in screen.

Small bright dots appear on your TFT display when you turn on your computer.

Small bright dots may appear on your screen display when you turn on your PC. Your display contains an extremely large number of thin-film transistors (TFT) and is manufactured using high-precision technology. Any small bright dots that may appear on your display are an intrinsic characteristic of the TFT manufacturing technology. Over a period of time, and depending on the usage of the computer, the brightness of the screen will deteriorate. This is also an intrinsic characteristic of the screen technology. When the computer is operated on battery power, the screen will dim and you may not be able to increase the brightness of the screen while on battery power.

PC Card problems

PC Card checklist

- ❖ Make sure the card is inserted properly into the slot.
See “Using PC Cards” in the electronic user’s guide for information about how to insert PC Cards.
- ❖ Make sure all cables are securely connected.
- ❖ Occasionally a defective PC Card slips through quality control. If another PCMCIA-equipped computer is available, try the card in that machine. If the card malfunctions again, it may be defective.

Resolving PC Card problems

Here are some common problems and their solutions:

The slot appears to be dead. PC Cards that used to work no longer work.

Check the PC Card status:

- 1 Click **Start**.
- 2 Click **My Computer** icon with the secondary button, then click **Properties**.

The System Properties dialog box appears.

- 3 Click the **Hardware** tab.
- 4 Click the **Device Manager** button.
- 5 Double-click the **PCMCIA adapter**.
- 6 Double-click the appropriate PC Card.

The operating system displays your PC Card’s Properties dialog box, which contains information about your PC Card configuration and status.

The computer stops working (hangs) when you insert a PC Card.

The problem may be caused by an I/O (input/output) conflict between the PCMCIA socket and another device in the system. Use Device Manager to make sure each device has its own I/O base address. See “Fixing a problem with device manager” in the electronic user’s guide for more information.

Since all PC Cards share the same socket, each card is not required to have its own address.

If you need further assistance

If you have followed the recommendations in this section and are still having problems, you may need additional technical assistance. This section contains the steps to take to ask for help.

Before you contact Toshiba

Since some problems may be related to the operating system or the program you are using, it is important to investigate other sources of assistance first.

Try the following before contacting Toshiba:

- ❖ Review the troubleshooting information in your operating system documentation.
- ❖ If the problem occurs while you are running a program, consult the program’s documentation for troubleshooting suggestions. Contact the software company’s technical support group for their assistance.

Detailed system specifications are available at www.ts.toshiba.com by selecting your particular product and model number, clicking **GO**, and then clicking the **Detailed Specs** link from the menu on the left, or just refer to the computer documentation shipped with your product.

For the number of a Toshiba dealer near you, see “Toshiba voice contact” in this section.

Contacting Toshiba

If you still need help and suspect that the problem is hardware-related, Toshiba offers a variety of resources to help you.

Toshiba's Technical Support Web site

For technical support, or to stay current on the most recent software and hardware options for your computer, and for other product information, be sure to regularly check the Toshiba Web site at pcsupport.toshiba.com.

Toshiba voice contact

Before calling Toshiba, make sure you have:

- ❖ Your computer's serial number
- ❖ The computer and any optional devices related to the problem
- ❖ Backup copies of your Windows® operating system and all other preloaded software on your choice of media
- ❖ Name and version of the program involved in the problem along with its installation media
- ❖ Information about what you were doing when the problem occurred
- ❖ Exact error messages and when they occurred

For technical support, call the Toshiba Global Support Centre:

Within the United States at (800) 457-7777

Outside the United States at (949) 859-4273

Power cord/cable connectors

Your computer features a universal power supply you can use worldwide. This section shows the shapes of the typical AC power cord/cable connectors for various parts of the world.



USA and Canada
(UL and CSA
approved)



United Kingdom
(BS approved)



Australia
(AS approved)

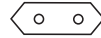

Europe
(VDA and
NEMKO approved)

Features and specifications

This section lists the computer's features. Numbered legal footnotes may also be found on page 65.

NOTE Product Series¹

The product specifications and configuration information are designed for a product Series. Your particular model may not have all the features and specifications listed or illustrated. For more detailed information about the features and specifications on your particular model, visit Toshiba's Web site at pcsupport.toshiba.com.

While Toshiba has made every effort at the time of publication to ensure the accuracy of the information provided herein, product specifications, configurations, prices, system/component/options availability are all subject to change without notice. For the most up-to-date product information about your computer, or to stay current with the various computer software or hardware options, visit Toshiba's Web site at pcsupport.toshiba.com.

Technology and processor

Processor	Intel® Core™ Solo Processor T1300
Central Processing Unit	(1.66 GHz, 2 MB L2 cache, 667 MHz FSB)
	Intel® Core™ Duo Processor T2300
	(1.66 GHz, 2 MB L2 cache, 667 MHz FSB)
	Intel® Core™ Duo Processor T2400
	(1.83 GHz, 2 MB L2 cache, 667 MHz FSB)
	Intel® Core™ Duo Processor T2500
	(2.00 GHz, 2 MB L2 cache, 667 MHz FSB)
	Intel® Core™ Duo Processor T2600
	(2.16 GHz, 2 MB L2 cache, 667 MHz FSB)* ²

*CPU performance in your computer product may vary from specifications under the following conditions:

- use of certain external peripheral products
- use of battery power instead of AC power
- use of certain multimedia, computer generated graphics or video applications
- use of standard telephone lines or low speed network connections
- use of complex modeling software, such as high end computer aided design applications
- use of several applications or functionalities simultaneously
- use of computer in areas with low air pressure (high altitude >1,000 meters or >3,280 feet above sea level)
- use of computer at temperatures outside the range of 5° C to 30° C (41° F to 86° F) or >25° C (77° F) at high altitude (all temperature references are approximate and may vary depending on the specific computer model – please refer to your Resource Guide, or visit the Toshiba website at www.pcsupport.toshiba.com for details).

*CPU performance may also vary from specifications due to design configuration.

Under some conditions, your computer product may automatically shut-down. This is a normal protective feature designed to reduce the risk of lost data or damage to the product when used outside recommended conditions. To avoid risk of lost data, always make back-up copies of data by periodically storing it on an external storage medium. Use your computer product only under recommended conditions. Read additional restrictions under “Environmental Conditions” in your product “Detailed Specs.” Contact Toshiba Technical Service and Support for more information.

Graphics (Graphics Processing Unit)	<p>Intel® Graphics Media Accelerator 950 or ATI Mobility™ Radeon® X1300*³</p> <p>*Graphics processor unit ("GPU") performance may vary depending on product model, design configuration, applications, power management settings and features utilized. GPU performance is only optimized when operating in AC power mode and may decrease considerably when operating in battery power mode.</p>
--	--

Power

Main battery	<p>Removable, rechargeable Lithium-Ion (Li-Ion) high-capacity battery (10.8V x 4000 mAh 6-cell)*⁴</p> <p>*Battery life may vary considerably from specifications depending on product model, configuration, applications, power management settings and features utilized, as well as the natural performance variations produced by the design of individual components. Published battery life numbers are achieved on select models and configurations tested by Toshiba at the time of publication. See "Detailed Specs" for specific battery measurement test. Recharge time varies depending on usage. Battery may not charge while computer is consuming full power. After a period of time, the battery will lose its ability to perform at maximum capacity and will need to be replaced. This is normal for all batteries. To purchase a new battery pack, see the accessories information that shipped with your computer or visit the Toshiba web site at www.accessories.toshiba.com.</p>
RTC battery	<p>Lithium-Ion (Li-Ion) or NiMH battery provides power for the internal real-time clock and calendar</p>

NOTE

The RTC battery does not charge while the computer is turned off even when the AC adapter is charging the computer.

Storage capacity

Hard Disk Drive (HDD) Capacity 2.5-inch removable drive and controller provides non-volatile storage for 40 GB, 60 GB, 80 GB, 100 GB, and 120 GB*⁵

*1 Gigabyte (GB) means $10^9 = 1,000,000,000$ bytes using powers of 10. The computer operating system, however, reports storage capacity using powers of 2 for the definition of 1 GB = $2^{30} = 1,073,741,824$ bytes, and therefore shows less storage capacity. Available storage capacity will also be less if the product includes one or more pre-installed operating systems, such as Microsoft Operating System and/or pre-installed software applications, or media content. Actual formatted capacity may vary.

Ports

S-Video out port	Lets you play DVD video on a projector or TV that accepts S-video inputs
DC-IN	Lets you connect the computer to AC power, using the AC adapter and power cord/cable
Headphone jack	Use the 3.5-mm headphone jack to connect stereo headphones or other audio output devices
Microphone jack	Use the 3.5-mm microphone stereo jack to connect an external monaural microphone or other audio input device
RGB (monitor) port	Use the 15-pin, analog VGA port to connect an external SVGA monitor (color or monochrome)
Modem port	Use the modem port to connect the internal modem directly to a telephone line (purchased separately) via an RJ11 connection
USB 2.0 ports	Support USB 2.0 peripherals (4 ports)
LAN port	Use the LAN port to connect to a LAN via an RJ45 connection
i.LINK [®] port	The i.LINK [®] port (IEEE 1394) provides fast data transfer rates (up to 400 Mbps)
PC Card slot	The PC Card slot lets you install one Type II or Type I PC Card. Minimum slot thickness: 5 mm
ExpressCard [™] Slot	The ExpressCard [™] slot supports the use of ExpressCard [™] media
Bridge Media Adapter Slot	The Bridge Media Adapter Slot can be used for additional storage via Secure Digital [™] Cards, xD-Picture Cards, Memory Stick, Memory Stick PRO, or MultiMediaCards [™]

Standard hardware

Memory (Main System)	<p>The system supports 256 MB of RAM, up to 4096 MB of RAM, depending on your configuration*⁶</p> <p>*Part of the main system memory may be used by the graphics system for graphics performance and therefore reduce the amount of main system memory available for other computing activities. The amount of main system memory allocated to support graphics may vary depending on the graphics system, applications utilized, system memory size and other factors. For PCs configured with 4 GB of system memory, the full system memory space for computing activities will be considerably less and will vary by model and system configuration.</p>
Display	<p>15.4-inch WXGA (measured diagonally) active matrix Thin Film Transistor (TFT) color LCD displays up to 16 million colors at 1280 x 800 (native resolution), or WSXGA+ at 1680 x 1050.*⁷</p> <p>Available configurations are: normal and TruBrite (High Brightness).</p> <p>*Small bright dots may appear on your screen display when you turn on your PC. Your display contains an extremely large number of thin-film transistors (TFT) and is manufactured using high-precision technology. Any small bright dots that may appear on your display are an intrinsic characteristic of the TFT manufacturing technology. Over a period of time, and depending on the usage of the computer, the brightness of the screen will deteriorate. This is also an intrinsic characteristic of the screen technology. When the computer is operated on battery power, the screen will dim and you may not be able to increase the brightness of the screen while on battery power.</p>
Communication	<p>Integrated V.92 56K modem*⁸</p> <p>*Due to FCC limitations, speeds of 53 kbps are the maximum permissible rates during downloads. Actual data transmission speeds will vary depending on line conditions.</p> <p>For more detailed information regarding your system's modem, visit the Toshiba Web site at toshiba.com.</p>
Networking	10/100 Ethernet or 1 Gbps Ethernet LAN adapter with RJ45 connection
Pointing device	Standard TouchPad™/Dual Mode Pad (optional) pointing device provides the functionality of a mouse or other pointing device
Sound controller	Realtek ALC861

Optical drive options

CD-RW/DVD-ROM
drive*⁹

READ: CD-ROM (24x), DVD-ROM (8x)

WRITE: CD-R (24x), CD-RW (4x)

Compatibility: CD-ROM (read only), CD-R (read/write),
CD-RW (read/write), DVD-ROM (read only), DVD-R
(read only), DVD-RW (read only), DVD-RAM (read only)

DVD SuperMulti
drive*⁹

READ: CD-ROM (24x), DVD-ROM (8x)

WRITE: CD-R (24x), CD-RW (4x), DVD-R (8x),
DVD-RW(4x), DVD+R (8x), DVD+RW (4x),
DVD+R (Double Layer (2.4x), DVD-RAM (5x)

Compatibility: CD-ROM (read only), CD-R (read/write),
CD-RW (read/write), DVD-ROM (read only), DVD-R
(read/ write), DVD-RW (read /write), DVD+R (read/write),
DVD+RW (read/write), DVD-RAM (read/write)

*Due to manufacturing and quality variations in third party optical media (e.g., CD or DVD) or optical media players/recorders, in certain cases, your Toshiba optical drive may not record on certain optical media that bear the applicable logo, or playback optical media recorded by other PCs or optical media recorders. Additionally, certain optical media recorded on your optical drive may not playback or operate properly on other PCs or optical media players. These problems are not due to any defect in your Toshiba PC or optical drive. Please refer to your PC's product specification for listing of specific format compatibilities.

Copy protection technology may also prevent or limit recording or viewing of certain optical media.

Wireless Communication

Wi-Fi®

The computer may come with an optional integrated Wi-Fi® wireless LAN mini PCI communication module providing wireless LAN functions.* ¹⁰

*Wireless connectivity and some features may require you to purchase additional software, external hardware or services. Availability of public wireless LAN access points may be limited. The transmission speed over the wireless LAN and the distance over which wireless LAN can reach may vary depending on surrounding electromagnetic environment, obstacles, access point design and configuration, and client design and software/hardware configurations. The actual transmission speed will be lower than the theoretical maximum speed. To use the Atheros SuperAG™ or SuperG™ wireless function, if available, your client and access point must support the corresponding feature. Performance of these functions may vary depending on the format of data transmitted.

NOTE

Toshiba recommends that Wi-Fi options be factory-installed at the time of order.

Legal Footnotes

1. Product Series

The product specifications and configuration information are designed for a product Series. Your particular model may not have all the features and specifications listed or illustrated. For more detailed information about the features and specifications on your particular model, visit Toshiba's Web site at pcsupport.toshiba.com.

While Toshiba has made every effort at the time of publication to ensure the accuracy of the information provided herein, product specifications, configurations, prices, system/component/options availability are all subject to change without notice. For the most up-to-date product information about your computer, or to stay current with the various computer software or hardware options, visit Toshiba's Web site at pcsupport.toshiba.com.

2. Processor (Central Processing Unit)

CPU performance in your computer product may vary from specifications under the following conditions:

- ❖ use of certain external peripheral products
- ❖ use of battery power instead of AC power
- ❖ use of certain multimedia, computer generated graphics or video applications
- ❖ use of standard telephone lines or low speed network connections
- ❖ use of complex modeling software, such as high end computer aided design applications
- ❖ use of several applications or functionalities simultaneously
- ❖ use of computer in areas with low air pressure (high altitude >1,000 meters or >3,280 feet above sea level)
- ❖ use of computer at temperatures outside the range of 5° C to 30° C (41° F to 86° F) or >25° C (77° F) at high altitude (all temperature references are approximate and may vary depending on the specific computer model – please visit the Toshiba website at www.pcsupport.toshiba.com for details).

CPU performance may also vary from specifications due to design configuration.

Under some conditions, your computer product may automatically shut-down. This is a normal protective feature designed to reduce the risk of lost data or damage to the product when used outside recommended conditions. To avoid risk of lost data, always make back-up copies of data by periodically storing it on an external storage medium. Use your computer product only under recommended conditions. Read additional restrictions under “Environmental Conditions” in your product “Detailed Specs.” Contact Toshiba Technical Service and Support for more information.

3. Graphics (Graphics Processing Unit)

GPU performance may vary depending on product model, design configuration, applications, power management settings and features utilized. GPU performance is only optimized when operating in AC power mode and may decrease considerably when operating in battery power mode.

4. Battery Life

Battery life may vary considerably from specifications depending on product model, configuration, applications, power management settings and features utilized, as well as the natural performance variations produced by the design of individual components. Published battery life numbers are achieved on select models and configurations tested by Toshiba at the time of publication. See “Detailed Specs” for specific battery measurement test. Recharge time varies depending on usage. Battery may not charge while computer is consuming full power. After a period of time, the battery will lose its ability to perform at maximum capacity and will need to be replaced. This is normal for all batteries. To purchase a new battery pack, see the accessories information that shipped with your computer or visit the Toshiba web site at www.accessories.toshiba.com.

5. Hard Disk Drive (HDD) Capacity

1 Gigabyte (GB) means $10^9 = 1,000,000,000$ bytes using powers of 10. The computer operating system, however, reports storage capacity using powers of 2 for the definition of $1 \text{ GB} = 2^{30} = 1,073,741,824$ bytes, and therefore shows less storage capacity. Available storage capacity will also be less if the product includes one or more pre-installed operating systems, such as Microsoft Operating System and/or pre-installed software applications, or media content. Actual formatted capacity may vary.

6. Memory (Main System)

Part of the main system memory may be used by the graphics system for graphics performance and therefore reduce the amount of main system memory available for other computing activities. The amount of main system memory allocated to support graphics may vary depending on the graphics system, applications utilized, system memory size and other factors. For PCs configured with 4 GB of system memory, the full system memory space for computing activities will be considerably less and will vary by model and system configuration.

7. Display

Small bright dots may appear on your screen display when you turn on your PC. Your display contains an extremely large number of thin-film transistors (TFT) and is manufactured using high-precision technology. Any small bright dots that may appear on your display are an intrinsic characteristic of the TFT manufacturing technology. Over a period of time, and depending on the usage of the computer, the brightness of the screen will deteriorate. This is also an intrinsic characteristic of the screen technology. When the computer is operated on battery power, the screen will dim and you may not be able to increase the brightness of the screen while on battery power.

8. Modem Speed

Due to FCC limitations, speeds of 53 kbps are the maximum permissible rates during downloads. Actual data transmission speeds will vary depending on line conditions.

9. Optical Media

Due to manufacturing and quality variations in third party optical media (e.g., CD or DVD) or optical media players/recorders, in certain cases, your Toshiba optical drive may not record on certain optical media that bear the applicable logo, or playback optical media recorded by other PCs or optical media recorders. Additionally, certain optical media recorded on your optical drive may not playback or operate properly on other PCs or optical media players. These problems are not due to any defect in your Toshiba PC or optical drive. Please refer to your PC's product specification for listing of specific format compatibilities.

Copy protection technology may also prevent or limit recording or viewing of certain optical media.

10. Wireless

Wireless connectivity and some features may require you to purchase additional software, external hardware or services. Availability of public wireless LAN access points may be limited. The transmission speed over the wireless LAN and the distance over which wireless LAN can reach may vary depending on surrounding electromagnetic environment, obstacles, access point design and configuration, and client design and software/hardware configurations. The actual transmission speed will be lower than the theoretical maximum speed. To use the Atheros SuperAG™ or SuperG™ wireless function, if available, your client and access point must support the corresponding feature. Performance of these functions may vary depending on the format of data transmitted.

Index

A

- AC adapter 28
- AC power light 28
- alarms low battery 46

B

- battery
 - alarms 46
 - changing 46
 - installing 46, 47
 - real-time clock (RTC) 45
 - removing 46, 47
- built-in features 58
- buttons
 - Optical drive 40

C

- CD/DVD button functionality 41
- CD/DVDs
 - inserting 42
- changing
 - main battery 46
- computer
 - moving 44
 - setting up 31
- computing tips 37
- connecting
 - AC adapter 28
 - power cable 29
 - printer 30
- critical applications 4

D

- DC-IN 29
- disc, positioning 42
- display
 - screen is blank 53

E

- error messages
 - program has performed an illegal operation 52

F

- FCC Notice “Declaration of Conformity Information” 4
- files
 - backing up 37
 - saving 37

I

- Industry Canada requirement 5
- inserting
 - PC Cards 36
- installing
 - main battery 46
 - memory modules 31
- internal drives 64

K

- keyboard
 - not working 53
 - unexpected characters 53

L

- lights
 - AC power 28

M

- main battery
 - changing 46
 - removing 46
- memory
 - adding 31
 - expansion slots 31
 - removing 35
- memory module

- inserting 33
- removing 32
- monitor
 - not working 54
- moving the computer 44
- O**
- Optical drive
 - buttons 40
- P**
- PC Card
 - checklist 55
 - computer stops working 56
 - inserting 36
 - problem solving 55
 - removing 37
- port
 - specifications 61
- power
 - cable 29
 - cable connectors 58
 - computer will not start 52
 - specifications 60
- power devices 64
- precautions 26, 29
- printer
 - connecting 30
- problem solving
 - computer hangs when PC Card inserted 56
 - computer will not power up 52
 - contacting Toshiba 56, 57
 - display is blank 53
 - external monitor 54
 - illegal operation 52
 - keyboard
 - not responding 53
 - keyboard produces unexpected characters 53
 - PC Card slots appear dead 55
 - program not responding 51
- protection of stored data 3

- R**
- real-time clock (RTC) battery 45
- removing
 - disc with computer off 43
 - main battery 46
 - PC Cards 37
- S**
- safety
 - precautions 26
- screen
 - blank 53
- secondary control button 39
- setting
 - battery alarms 46
- setting up
 - AC adapter 28
 - computer 31
- specifications 58
 - ports 61
 - power 60
 - standard hardware 62
 - storage capacity 61
- standard hardware, specifications 62
- storage capacity, specifications 61
- stored data protection 3

- T**
- tips on computing 37
- TouchPad
 - using 39

- W**
- Web sites 57
- wireless interoperability 8

TOSHIBA

PMA500260012

03/06

